

Moreno Baricevic

CNR-IOM DEMOCRITOS
Trieste, ITALY

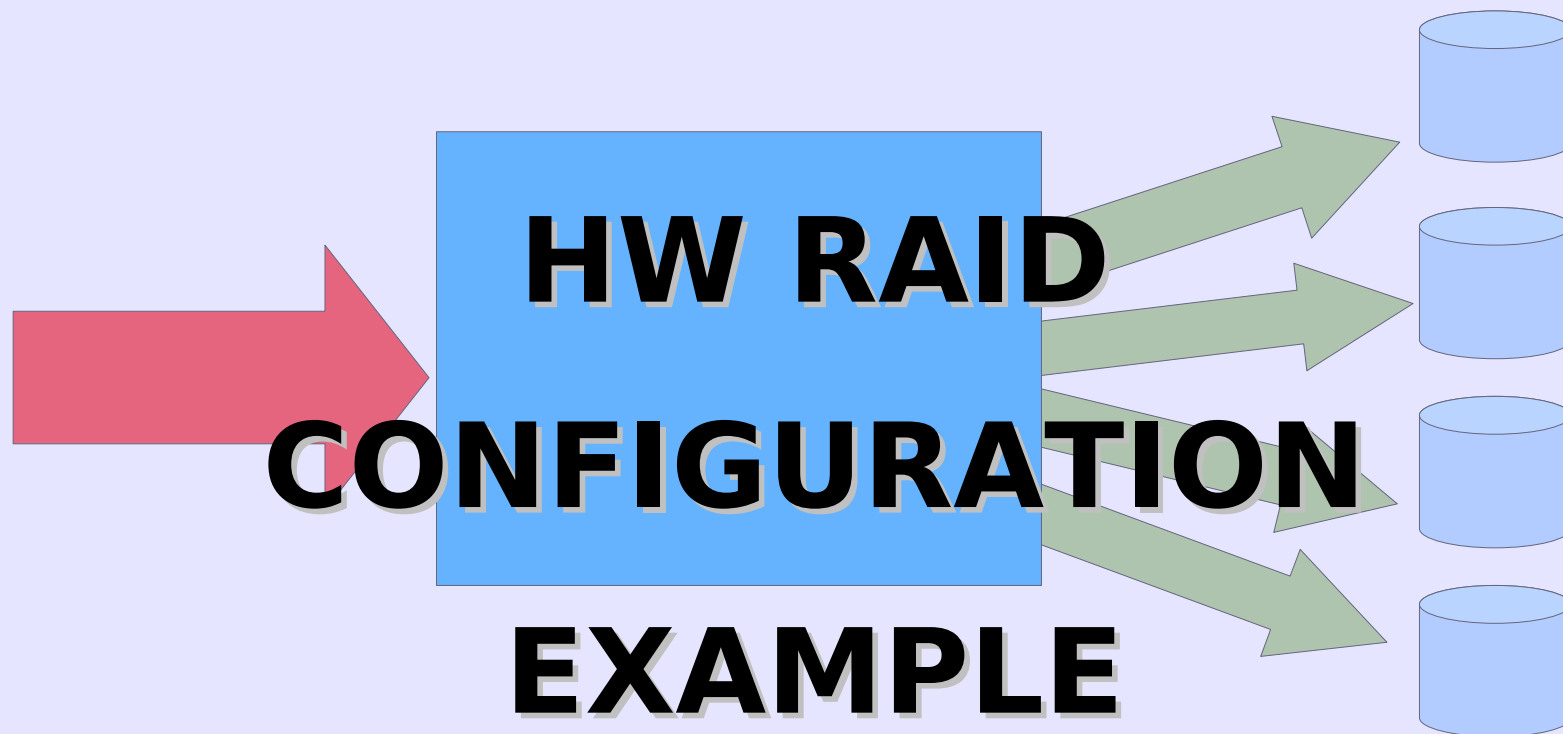

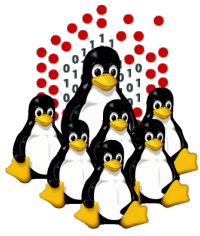

RAID SET 1 + HOT SPARE

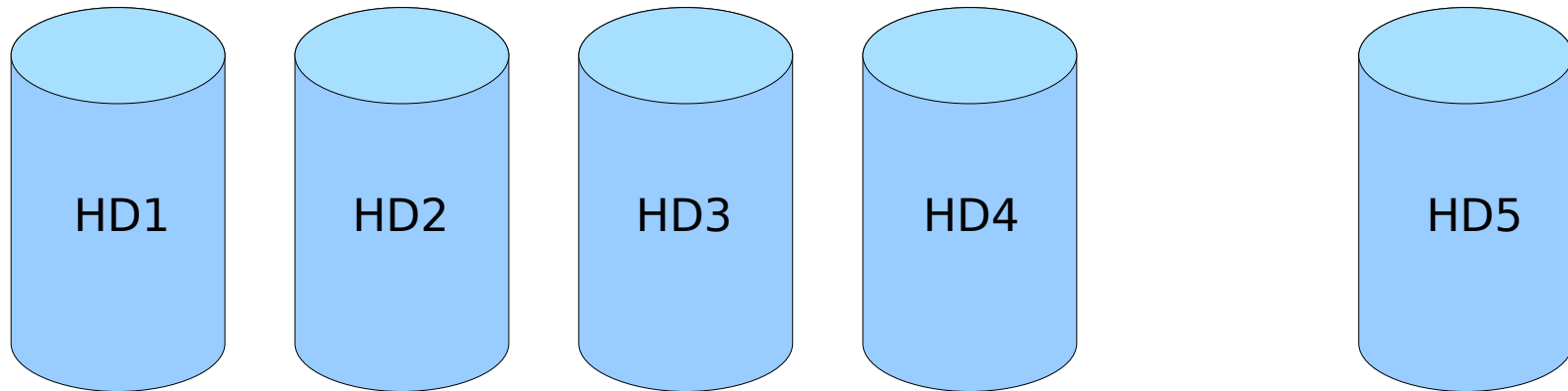

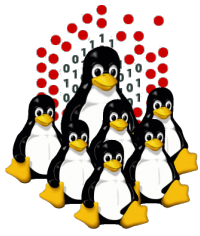

RAID SET 1 + HOT SPARE

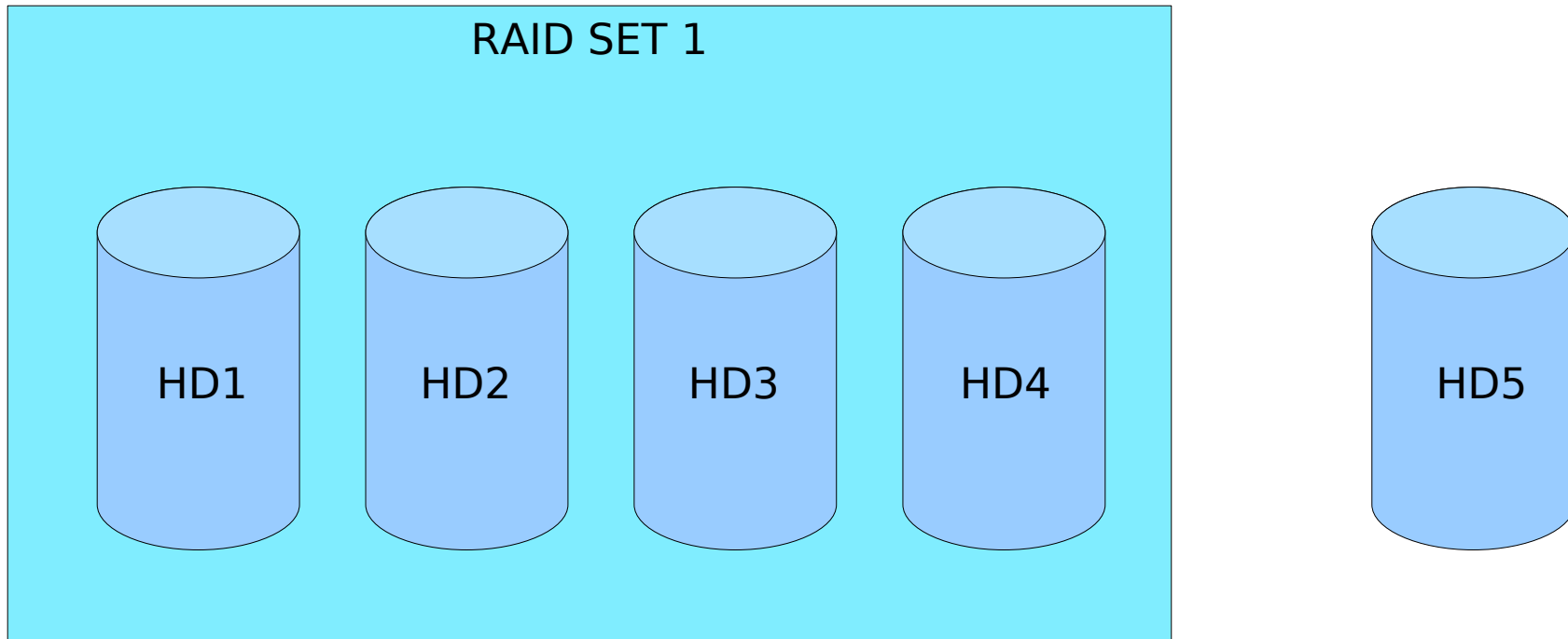

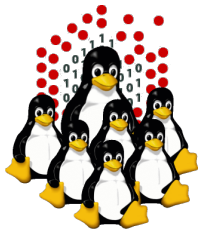

RAID SET 1 + HOT SPARE

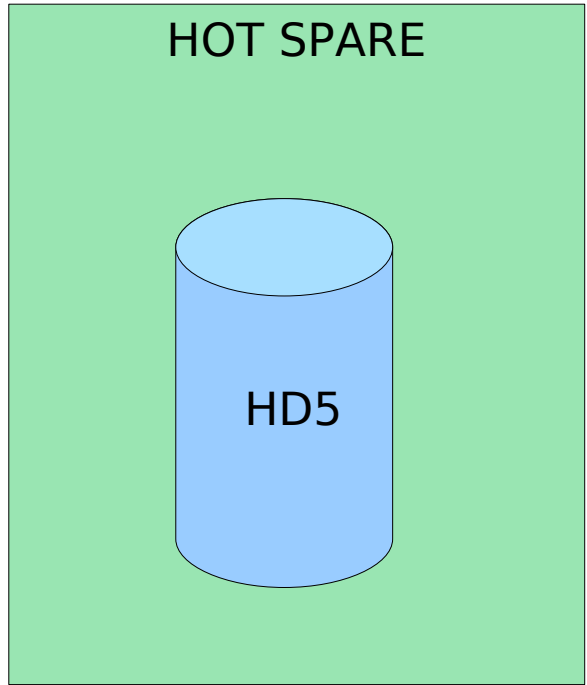
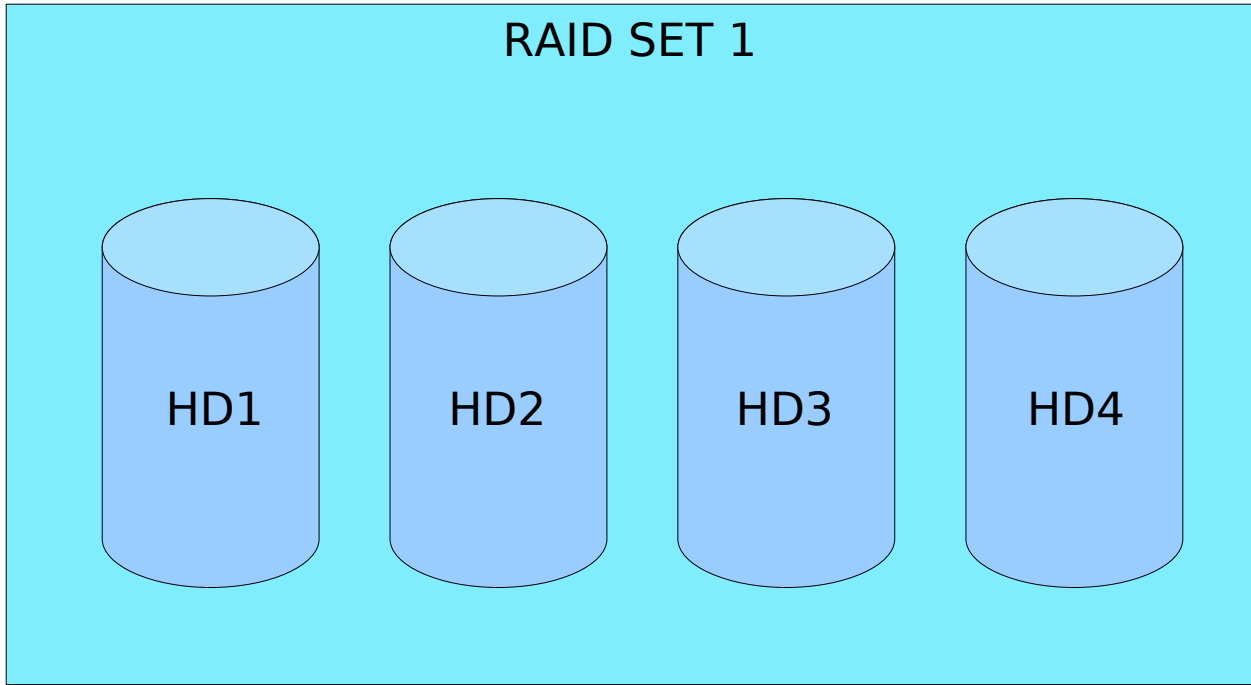



VOLUME SET 1 (as RAID 6 for reliability)

sda1: /boot

sda2: LVM: /, /tmp, /var, ...

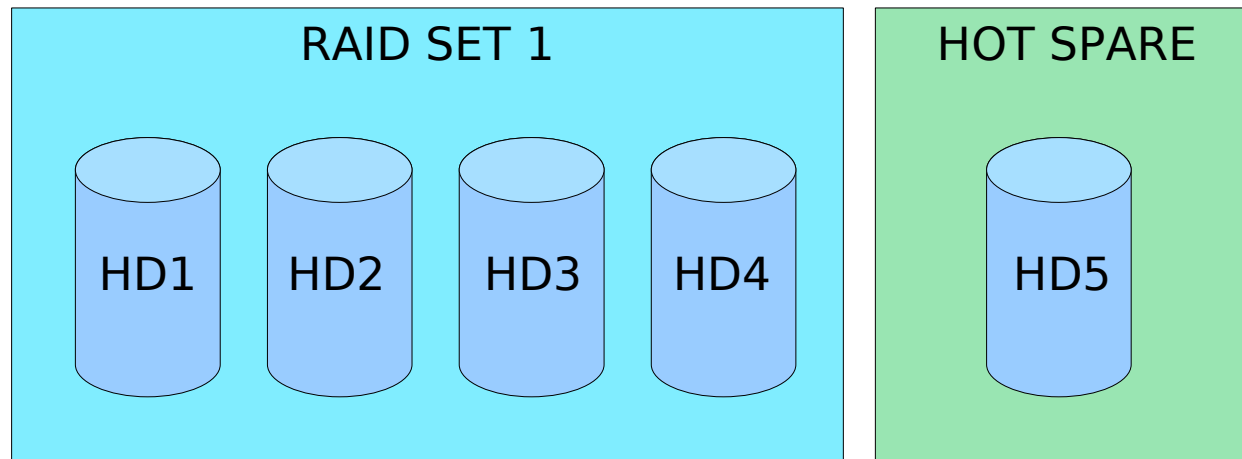

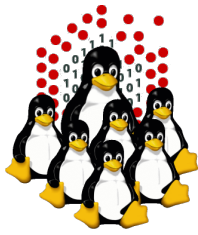

VOLUME SET 1 (as RAID 6 for reliability)

sda1: /boot

sda2: LVM: /, /tmp, /var, ...

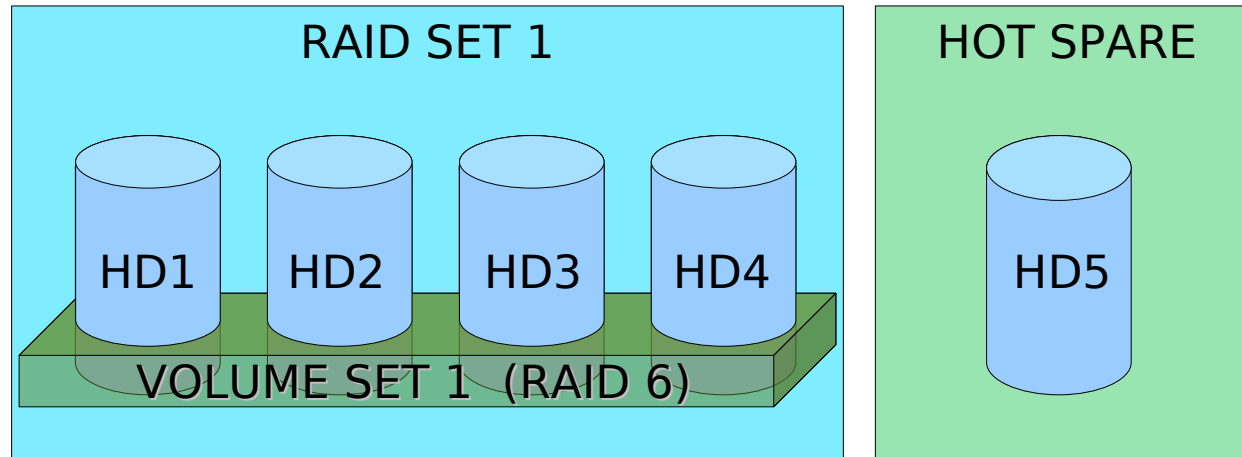

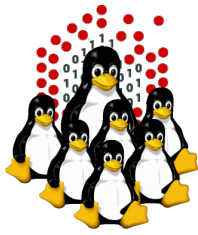

VOLUME SET 1 (as RAID 6 for reliability)

sda1: /boot

sda2: LVM: /, /tmp, /var, ...

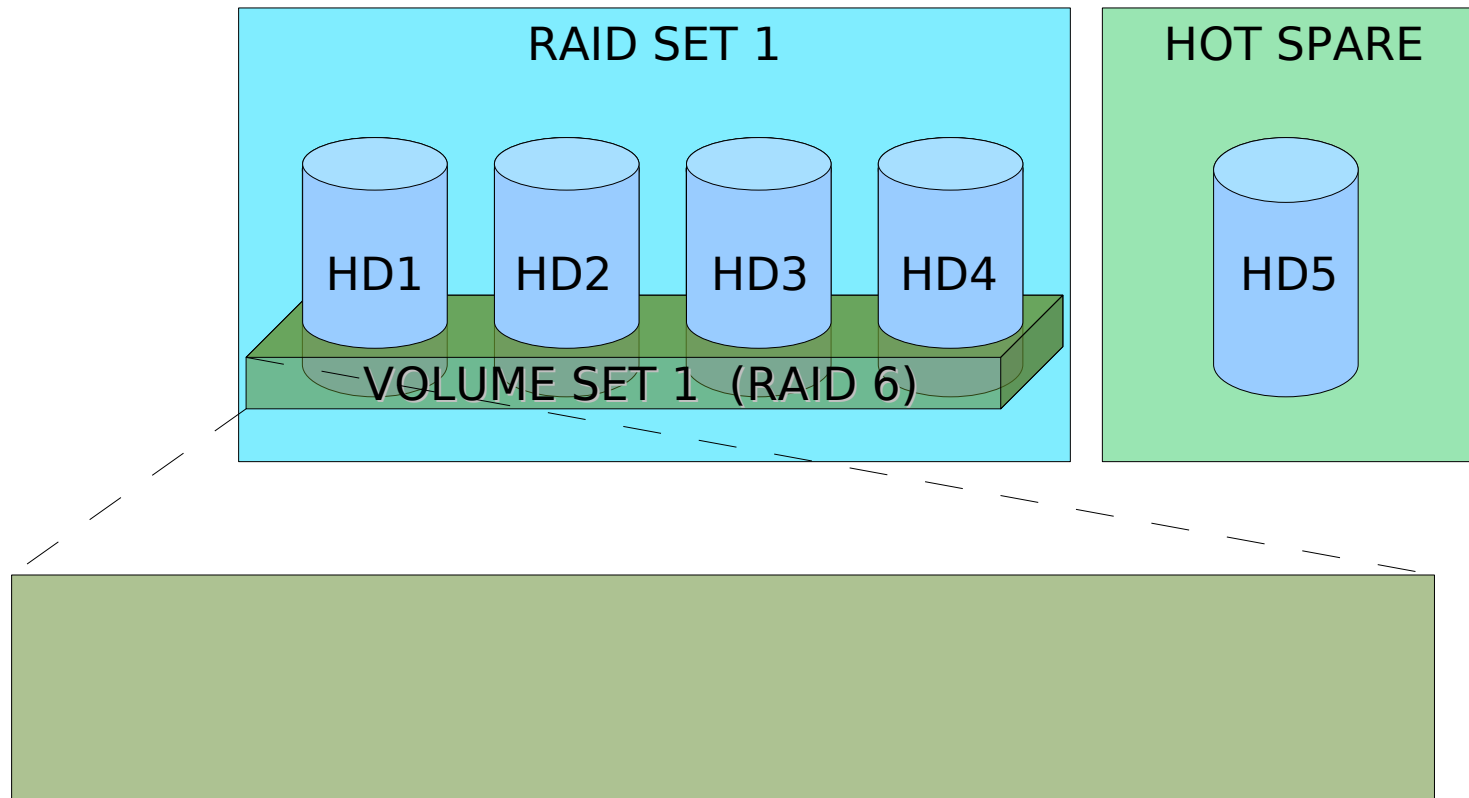

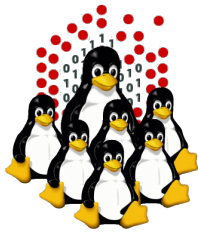

VOLUME SET 1 (as RAID 6 for reliability)

sda1: /boot

sda2: LVM: /, /tmp, /var, ...

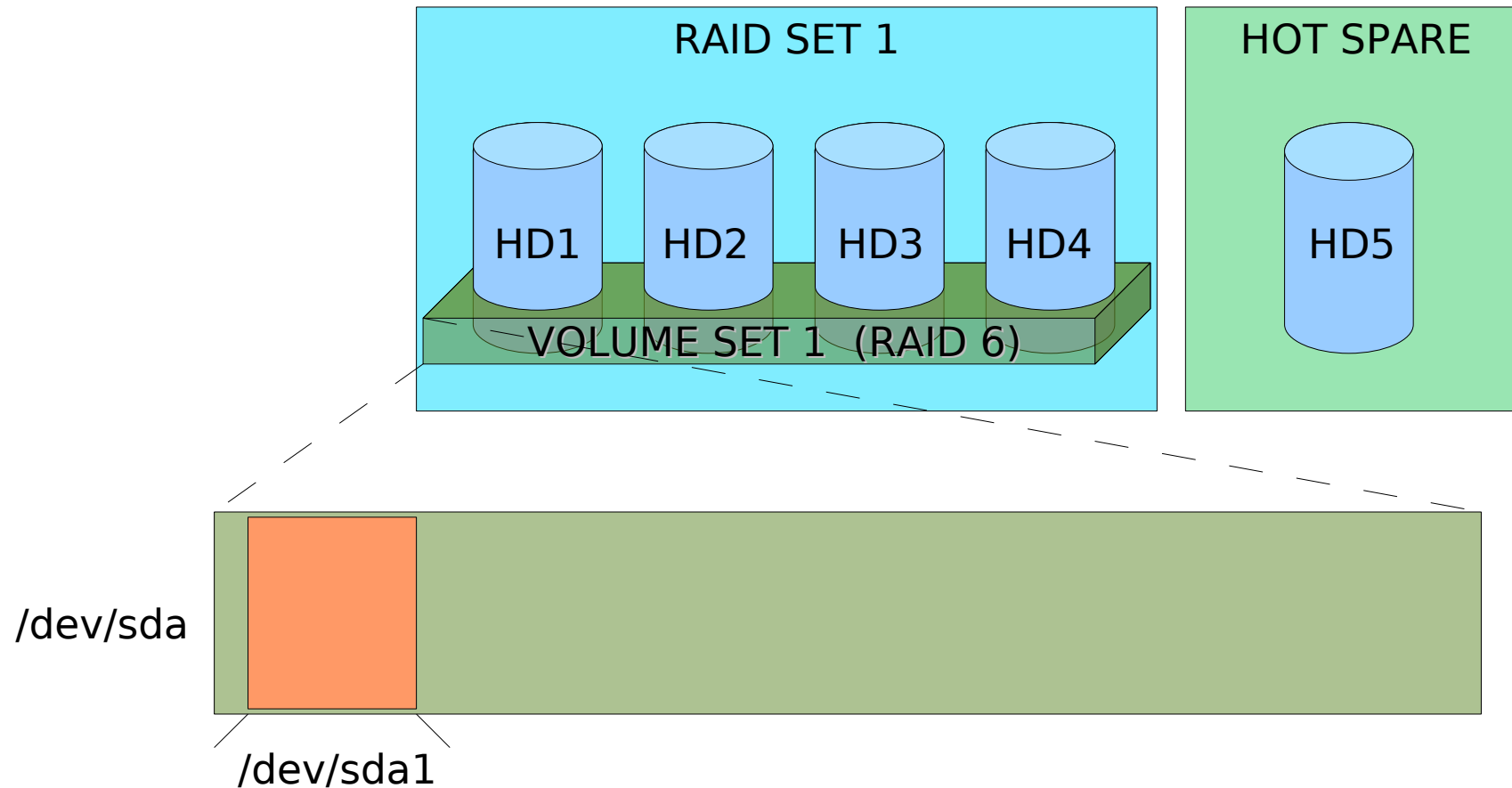

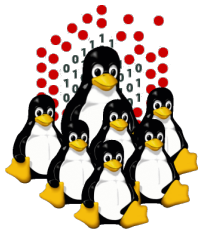

VOLUME SET 1 (as RAID 6 for reliability)

sda1: /boot

sda2: LVM: /, /tmp, /var, ...

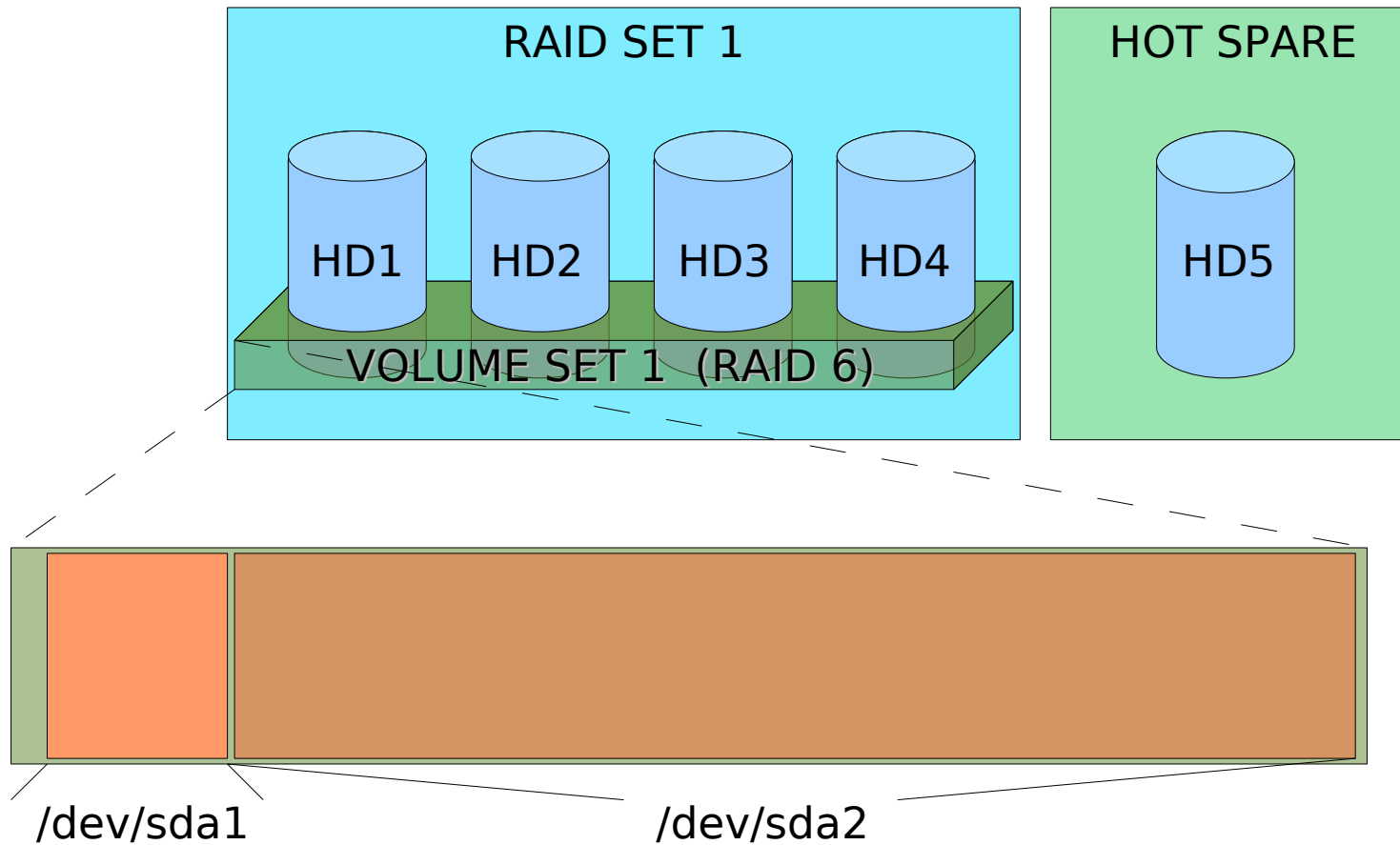

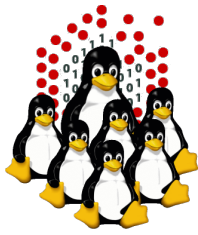

VOLUME SET 1 (as RAID 6 for reliability)

sda1: /boot

sda2: LVM: /, /tmp, /var, ...

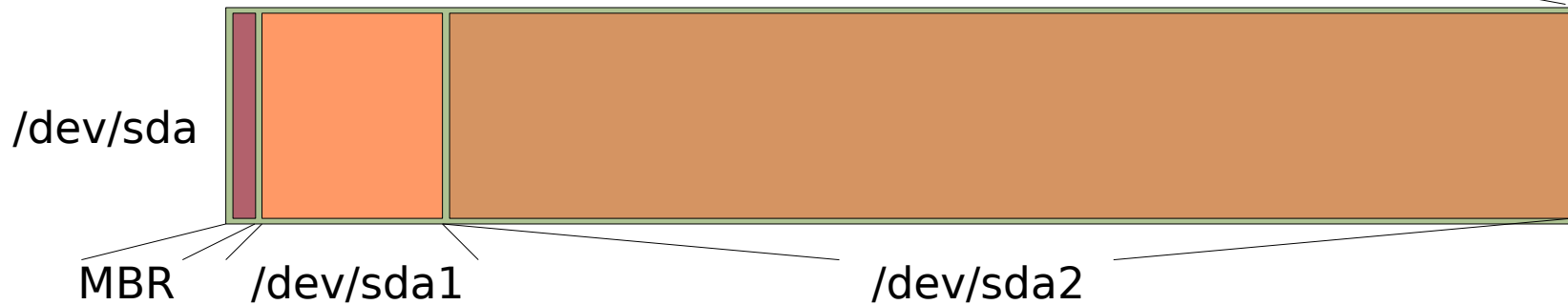
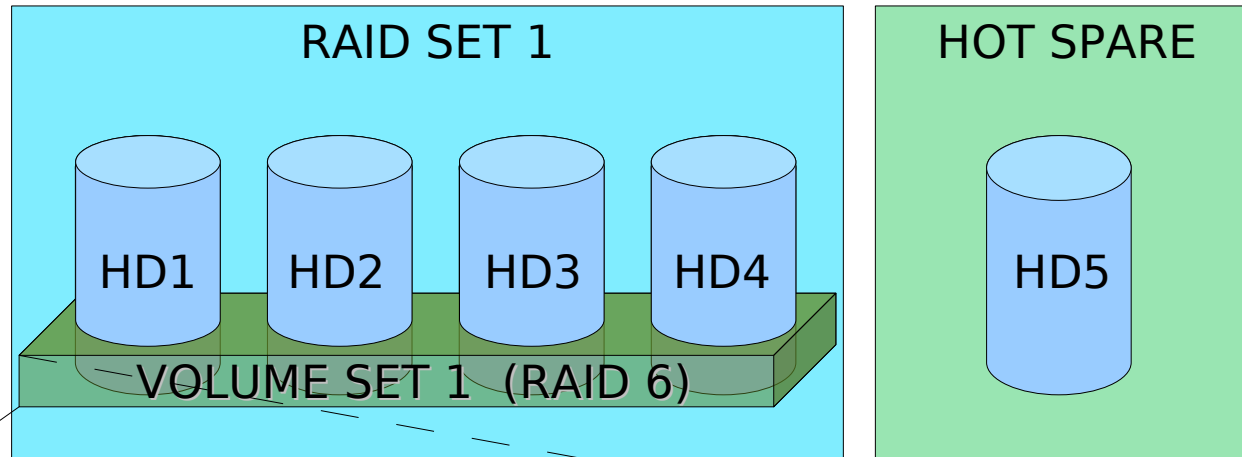

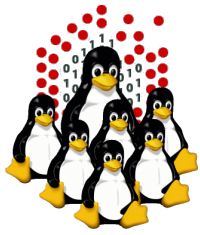

VOLUME SET 1 (as RAID 6 for reliability)

sda1: /boot

sda2: LVM: /, /tmp, /var, ...

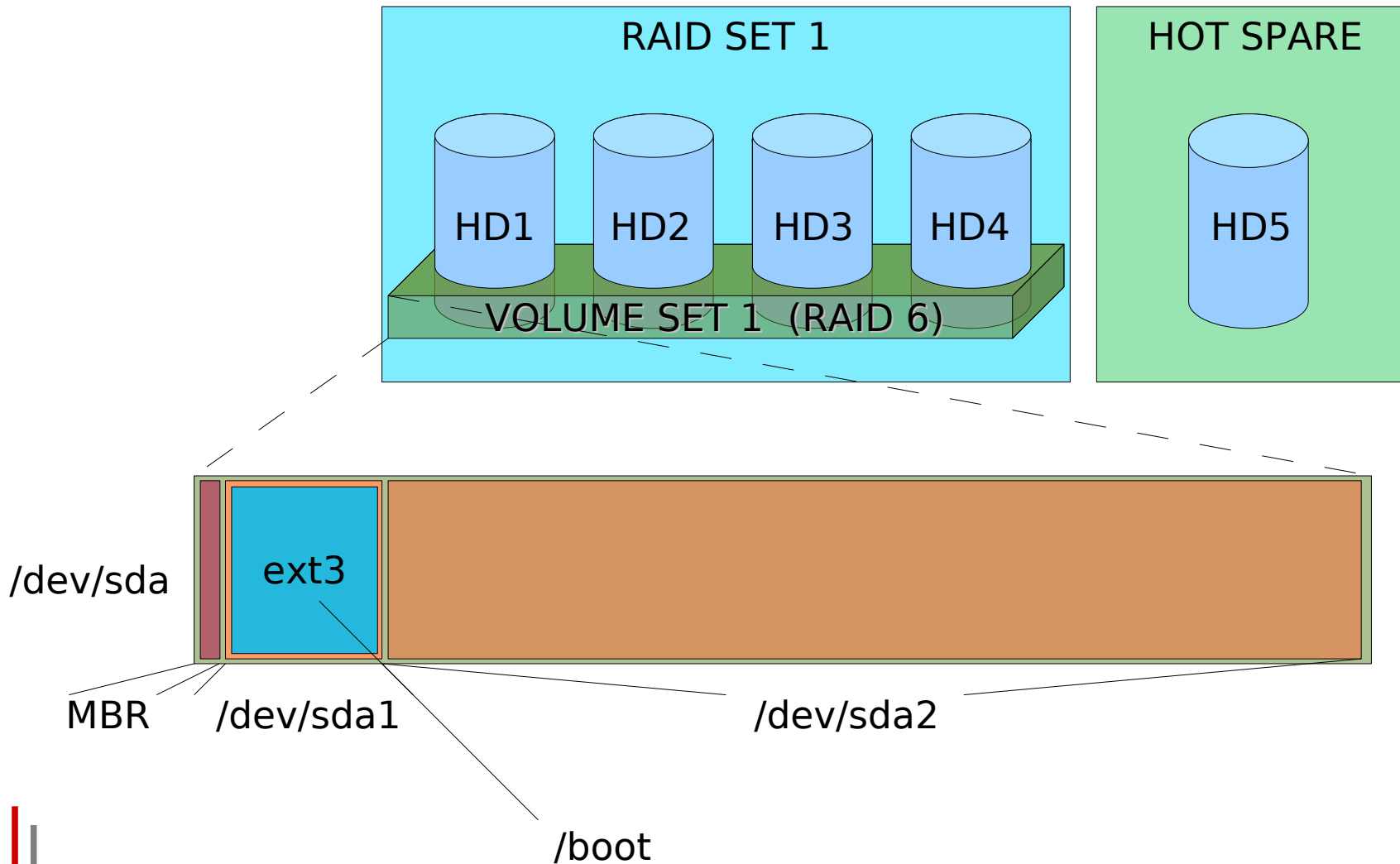



VOLUME SET 1 (as RAID 6 for reliability)

sda1: /boot

sda2: LVM: /, /tmp, /var, ...

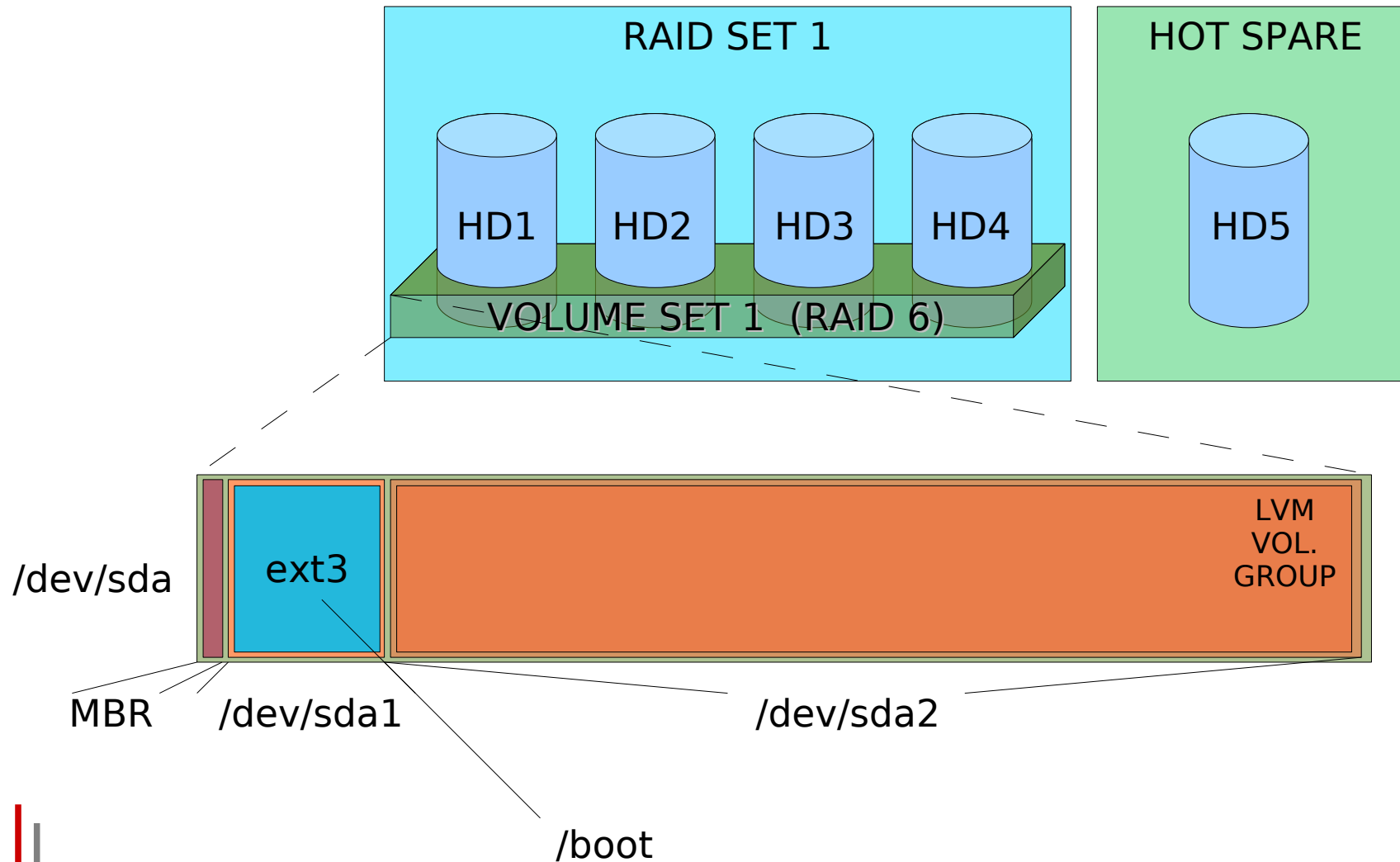

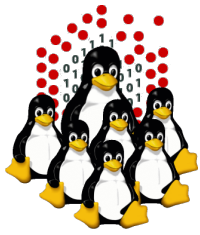

VOLUME SET 1 (as RAID 6 for reliability)

sda1: /boot

sda2: LVM: /, /tmp, /var, ...

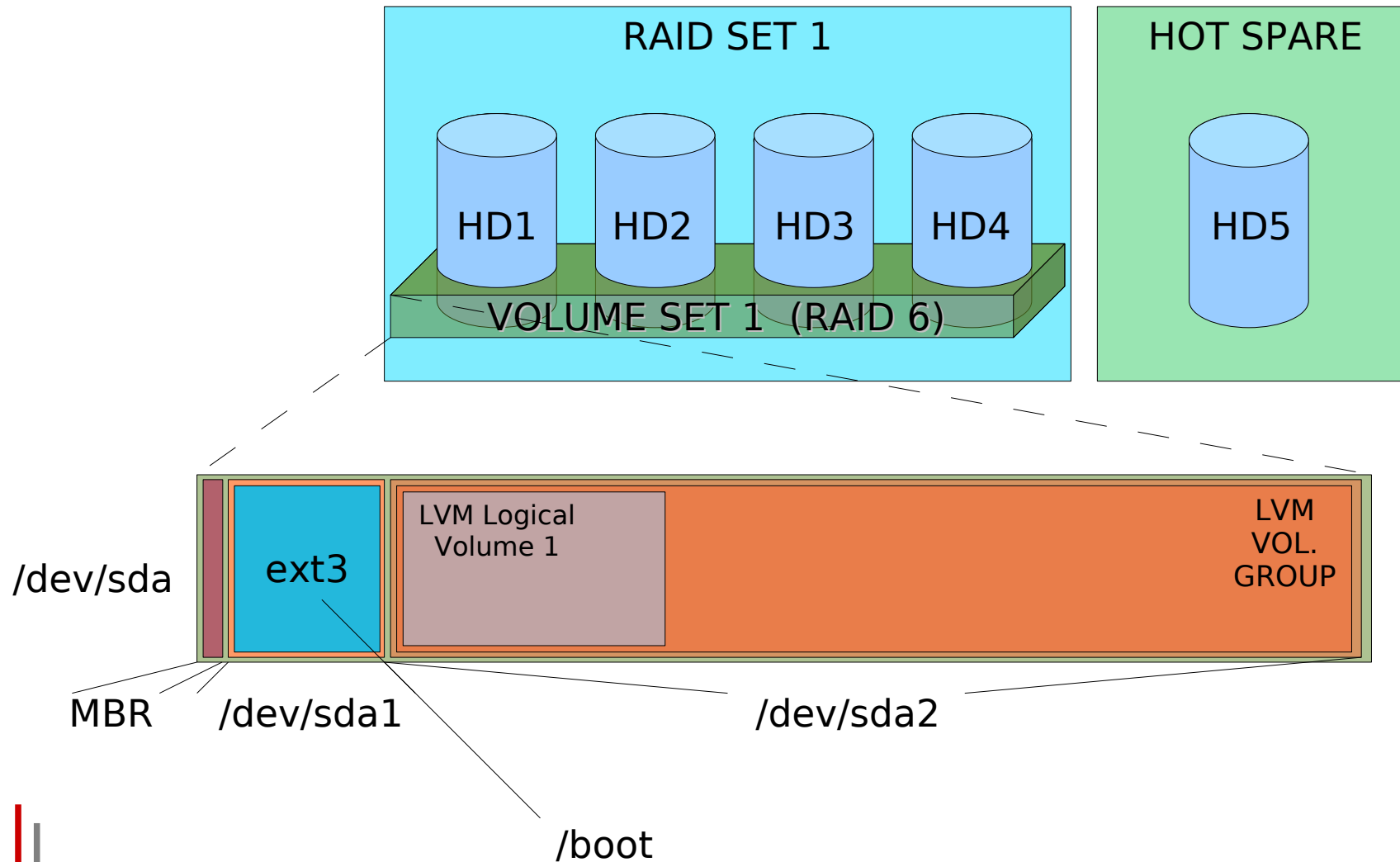

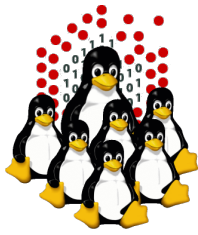

VOLUME SET 1 (as RAID 6 for reliability)

sda1: /boot

sda2: LVM: /, /tmp, /var, ...

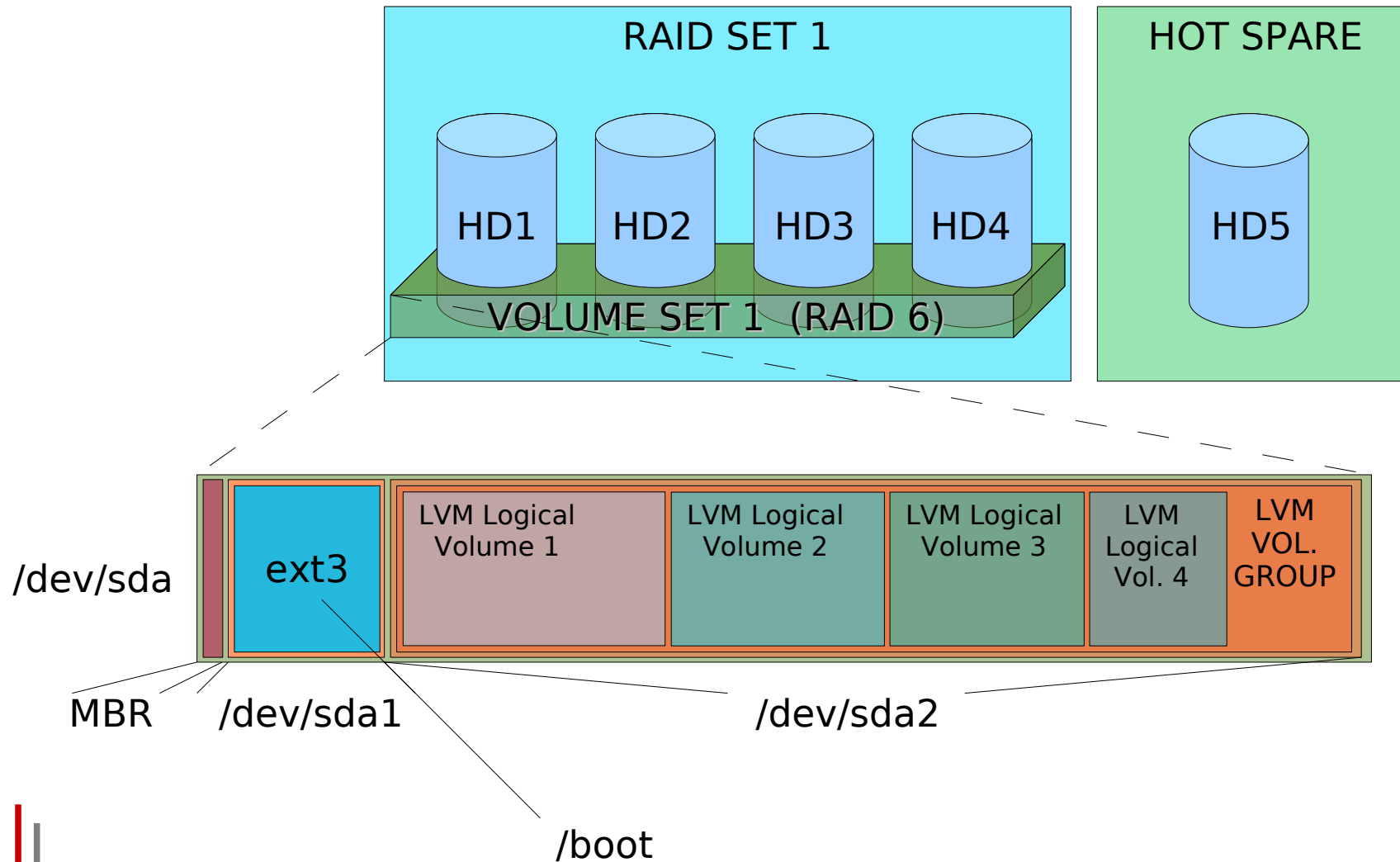

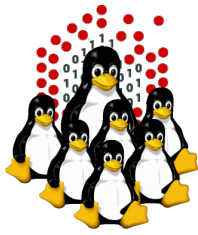

VOLUME SET 1 (as RAID 6 for reliability)

sda1: /boot

sda2: LVM: /, /tmp, /var, ...

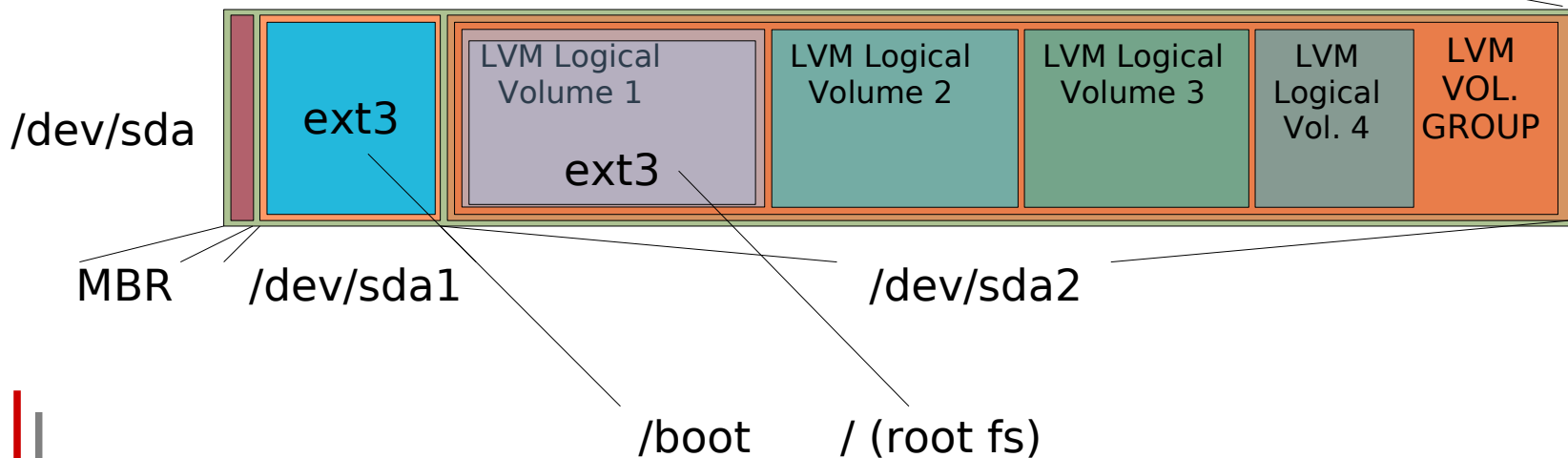
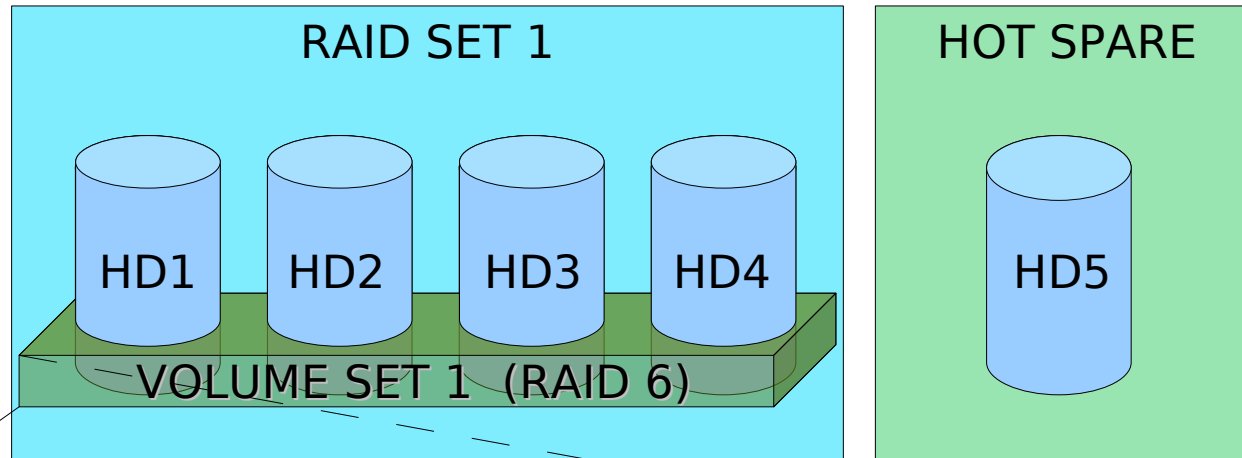

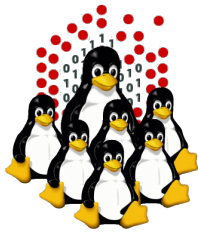

VOLUME SET 1 (as RAID 6 for reliability)

sda1: /boot

sda2: LVM: /, /tmp, /var, ...

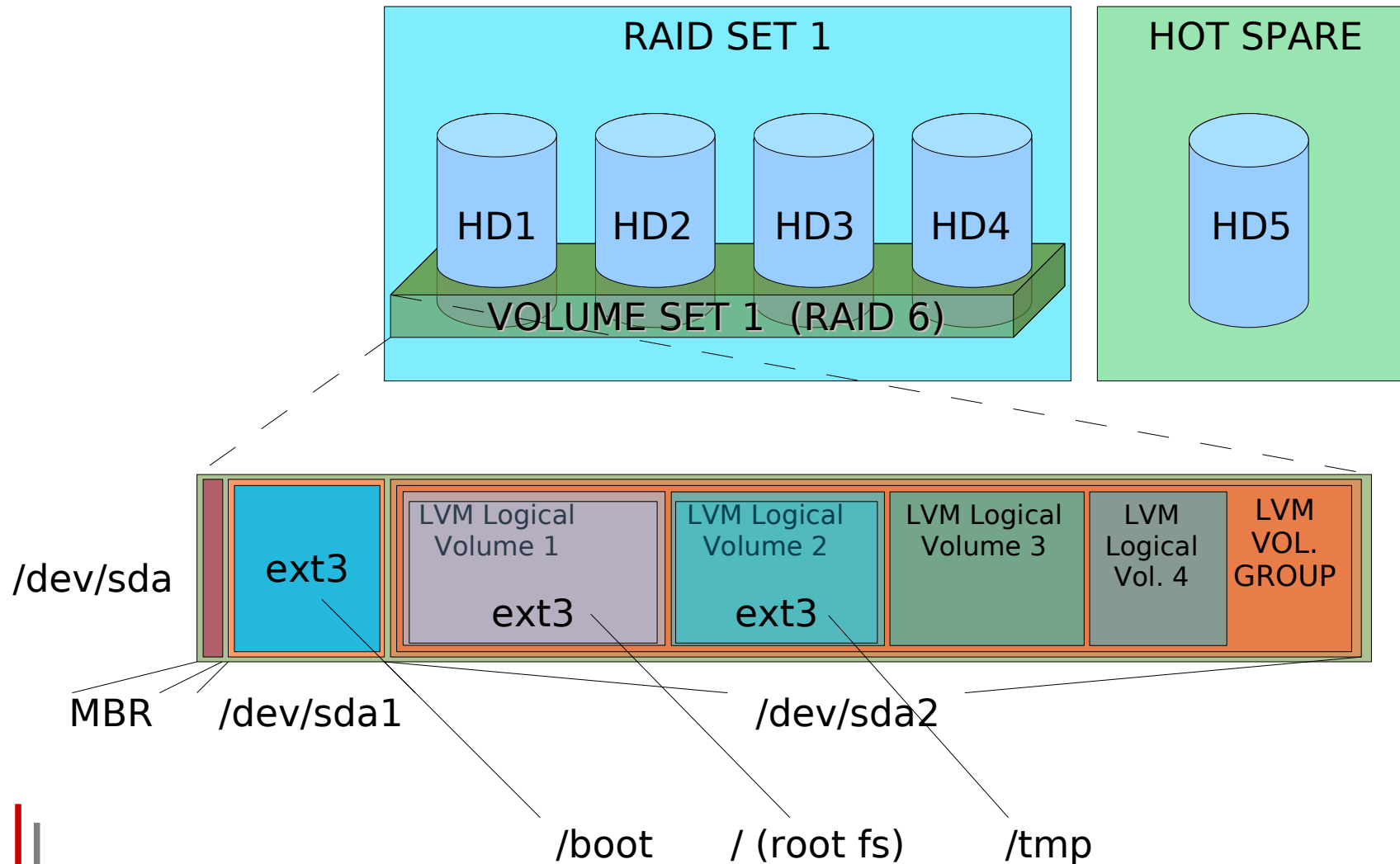



VOLUME SET 1 (as RAID 6 for reliability)

sda1: /boot

sda2: LVM: /, /tmp, /var, ...

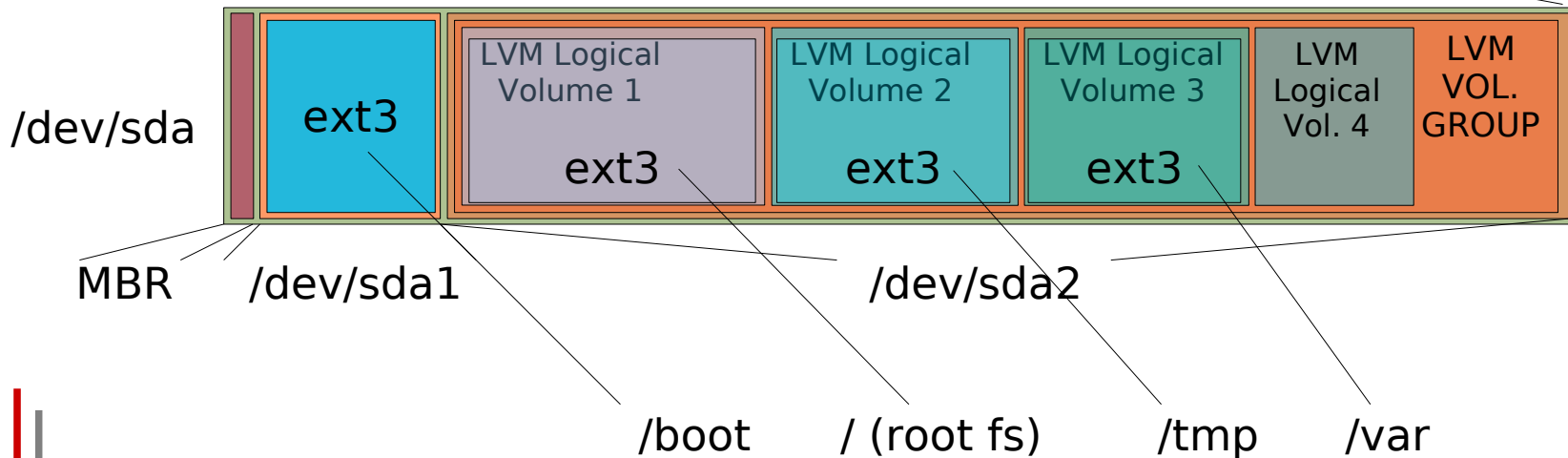
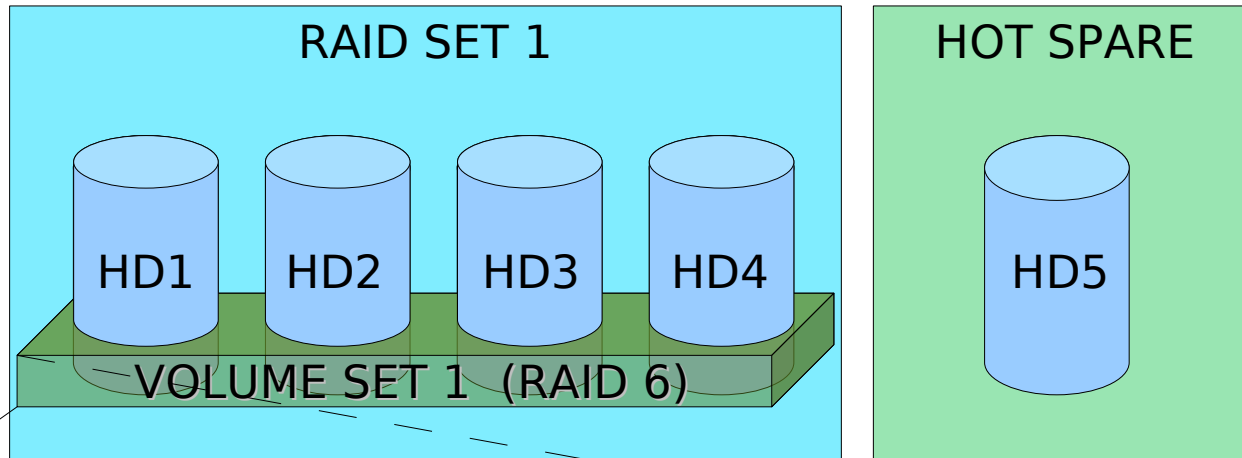

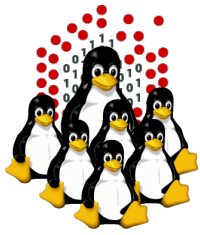

VOLUME SET 1 (as RAID 6 for reliability)

sda1: /boot

sda2: LVM: /, /tmp, /var, ...

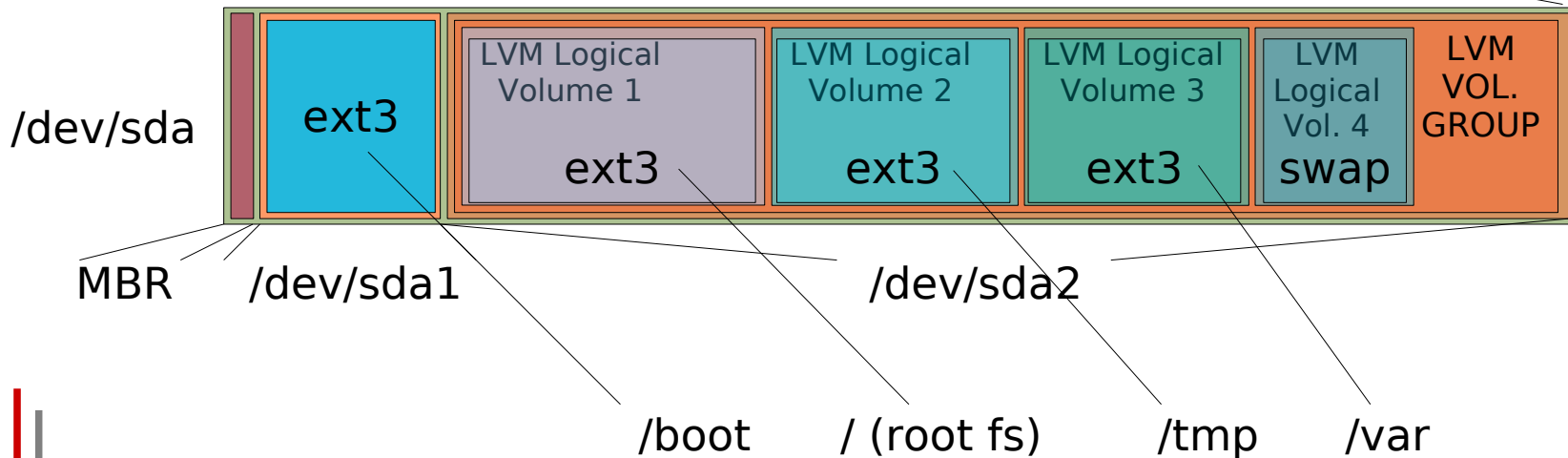
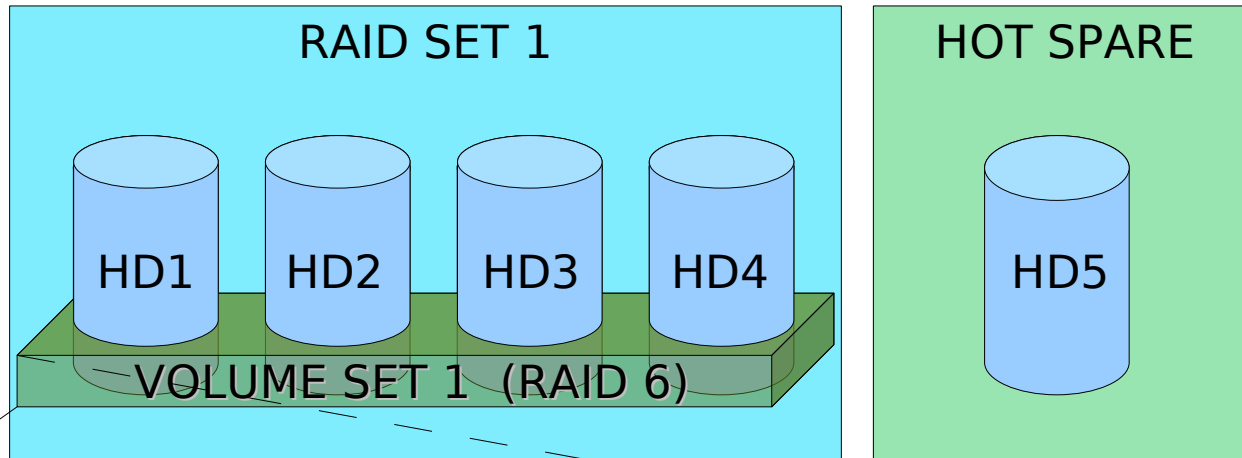

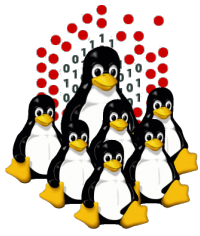

VOLUME SET 2 (as RAID 6 for reliability)

sdb1: /home

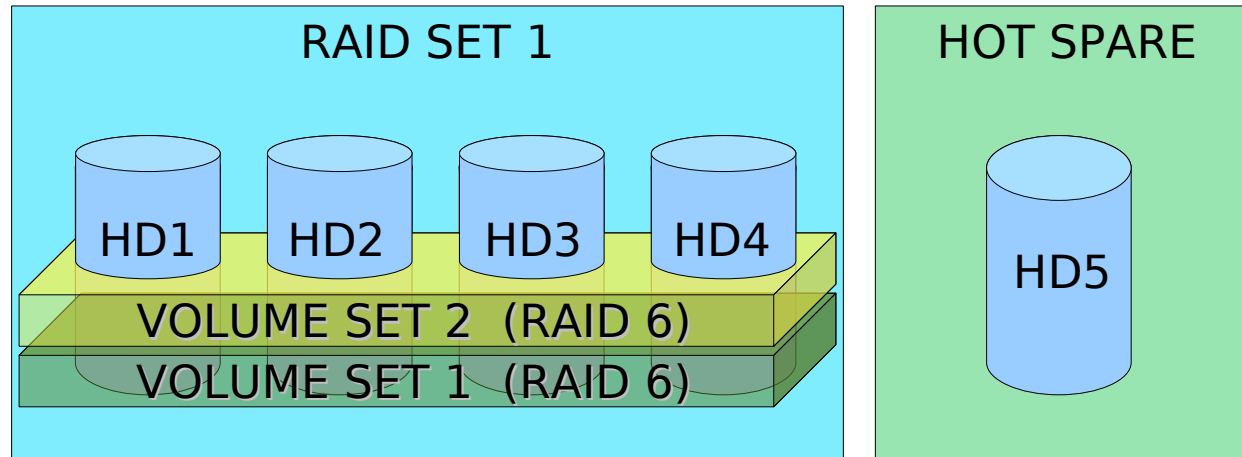

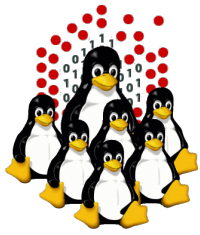

VOLUME SET 2 (as RAID 6 for reliability)

sdb1: /home

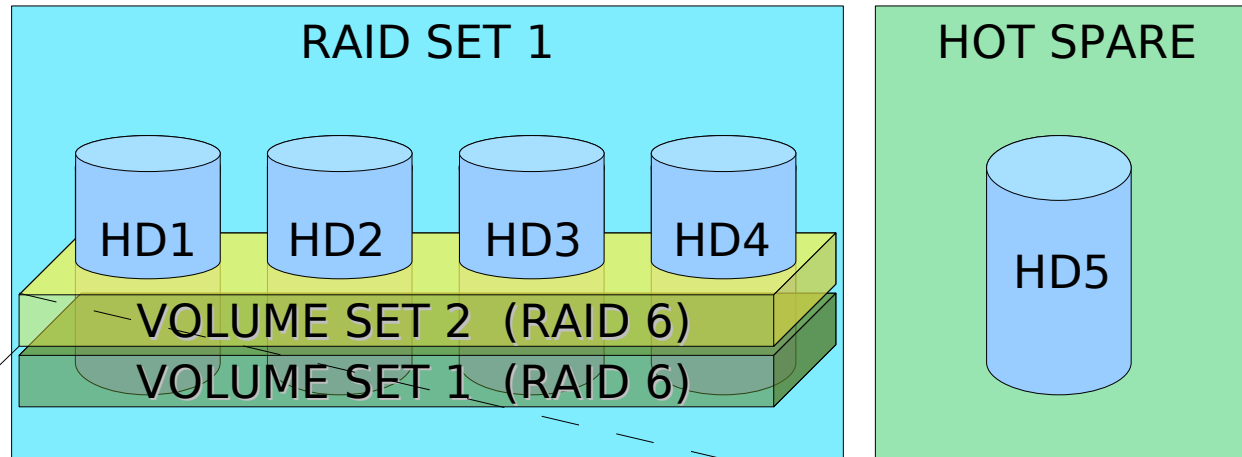

/dev/sdb

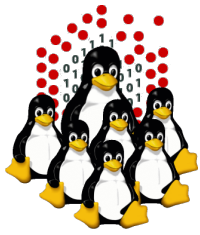

VOLUME SET 2 (as RAID 6 for reliability)

sdb1: /home

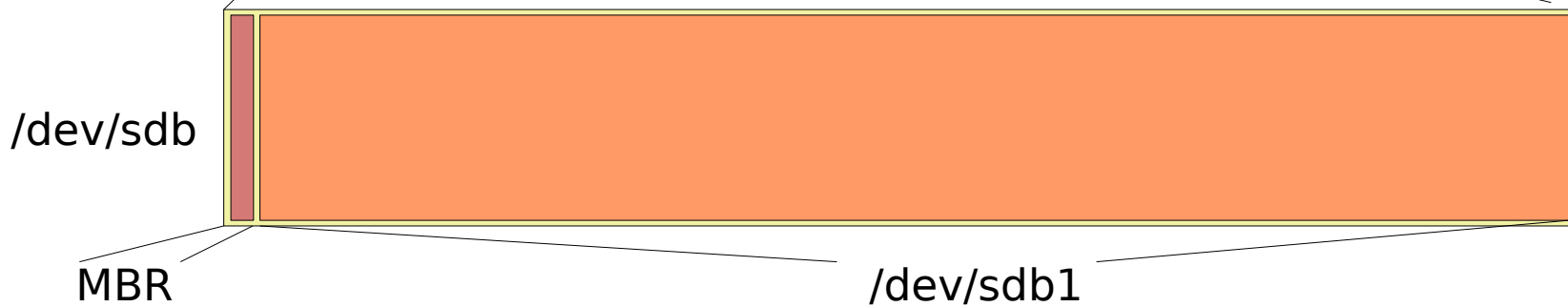
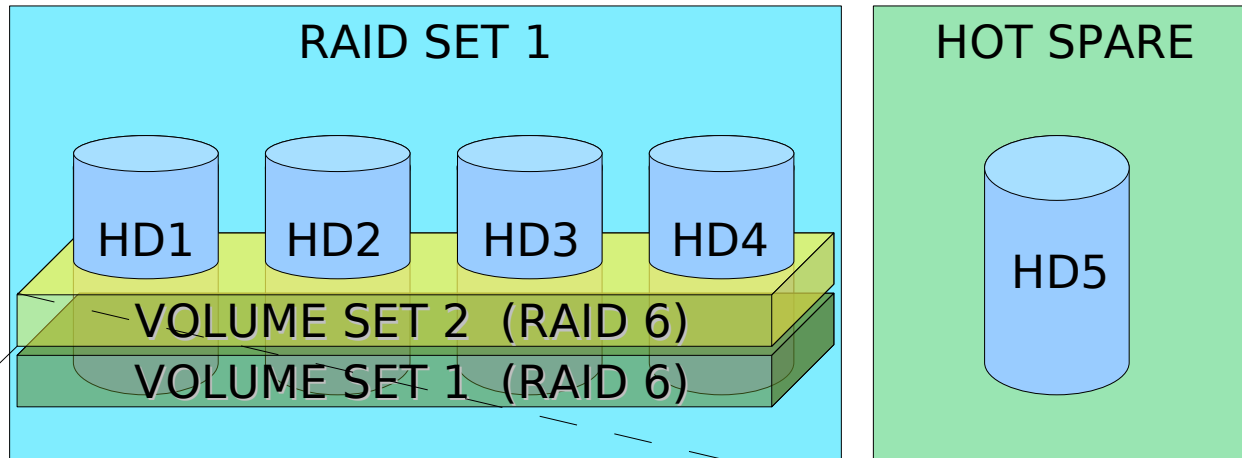

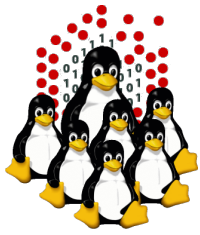

VOLUME SET 2 (as RAID 6 for reliability)

sdb1: /home

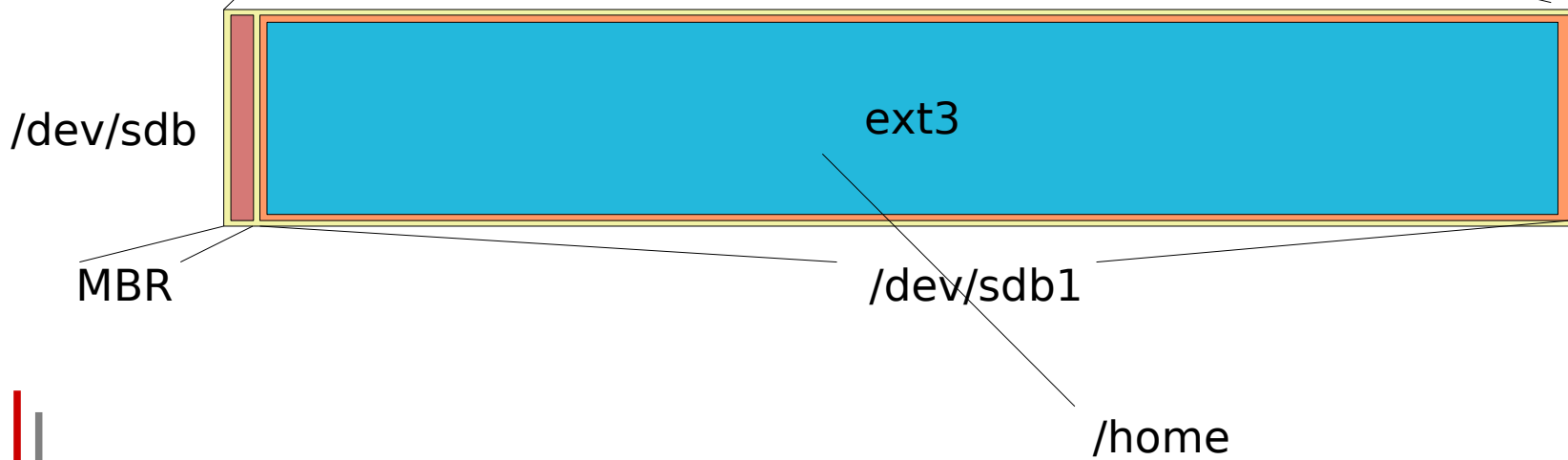
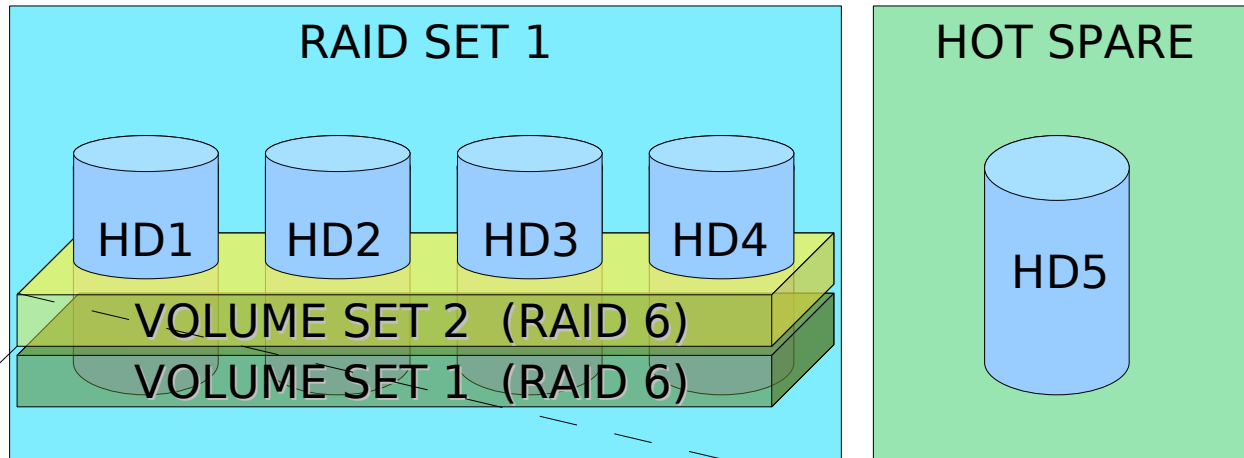

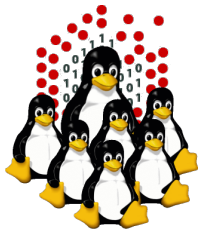

VOLUME SET 3 (as RAID 0 for speed)

`sdc1: /scratch`

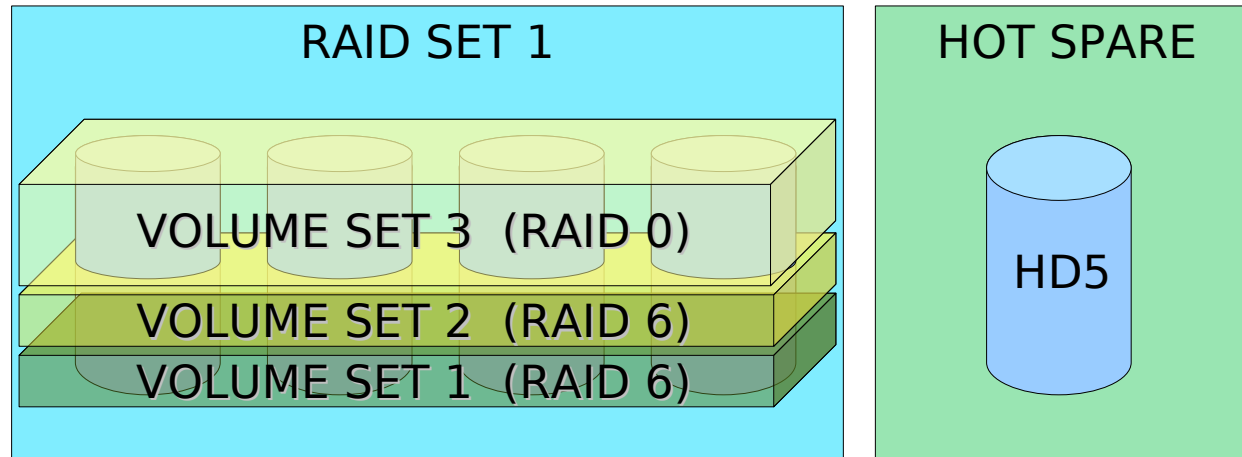

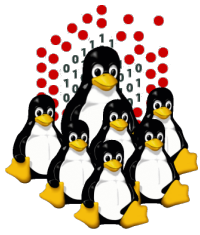

VOLUME SET 3 (as RAID 0 for speed)

sdc1: /scratch

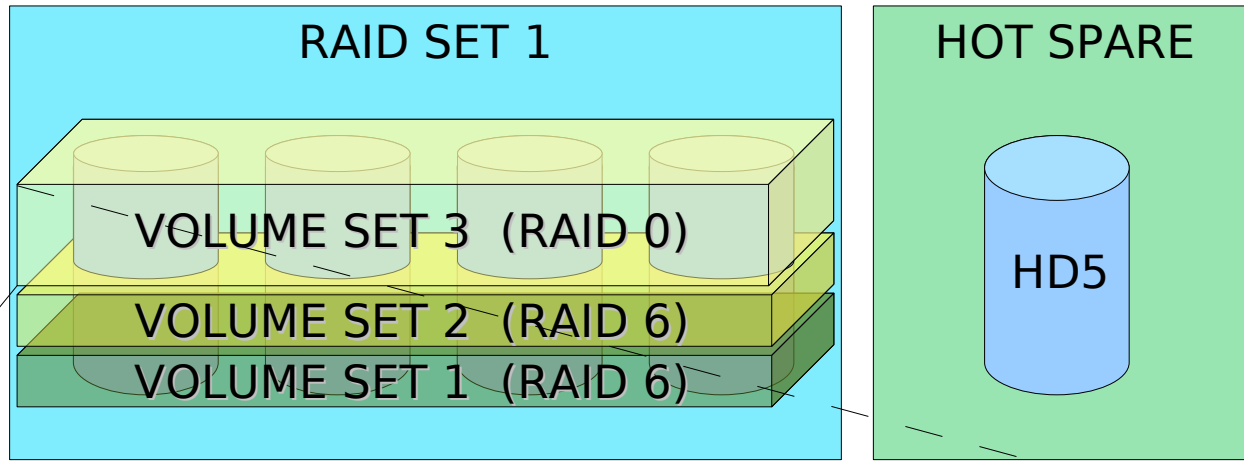

/dev/sdc



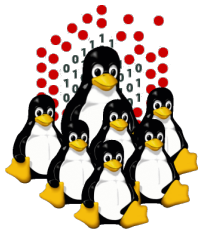

VOLUME SET 3 (as RAID 0 for speed)

`sdc1: /scratch`

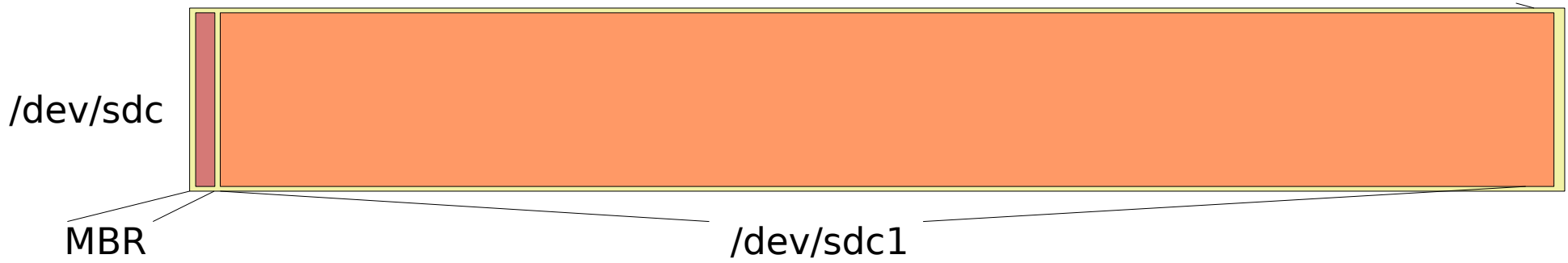
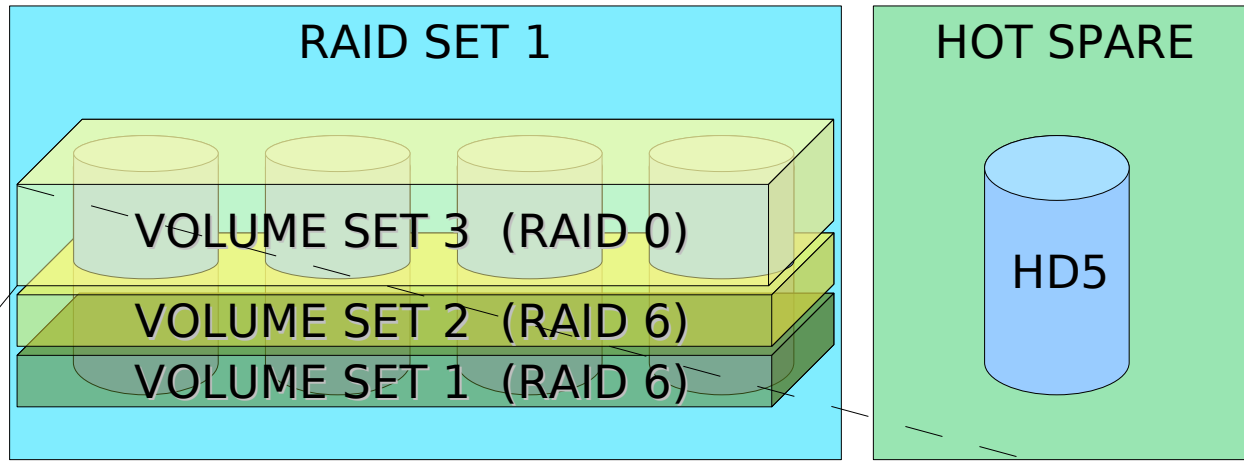

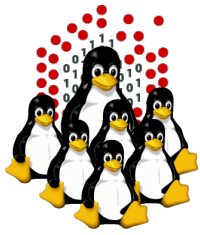

VOLUME SET 3 (as RAID 0 for speed)

sdc1: /scratch

